



No. **CHD40009-008J-00**

参考資料
Reference data

TECHNICAL DATA

MODEL: CWB050-12

SANKEN ELECTRIC CO.,LTD.

CHD40009-008J-00
March 21, 2016

内容 (CONTENTS)

1.入力特性 (Input Characteristics)3
入力電流 (Input Current)3
入力電力 (Input Power)3
力率(Power Factor)3
効率 (Efficiency)3
突入電流 (Inrush Current)3
漏洩電流 (Leakage Current)3
起動停止電圧 (Startup Voltage & Stop Voltage)3
入力瞬断時間 (Hold up time)3
2.出力特性 (Output Characteristics)4
出力偏差 (Output Standard Voltage)4
入出力相互変動 (Input/Output Voltage Change Fluctuation)4
温度ドリフト (Temperature Drift)4
経時ドリフト (Warm-Up Drift)4
リップル電圧 (Ripple Voltage)4
リップルノイズ電圧 (Ripple Noise Voltage)4
出力電圧可変範囲 (Output Voltage Variable Range)4
3.保護特性 (Protection Characteristics)5
過電流検出値 (Over Current Protection)5
過電圧検出値 (Over Voltage Protection)5
リセット時間 (Reset Time)5
4.環境試験 (Environment Test)5
振動試験 (Vibration)5
高温スタート (Power on at high temp)5
低温スタート (Power on at low temp)5
耐衝撃 (Shock)5
5.耐ノイズ特性 (Noise Tolerance Characteristics)5
注入ノイズ耐量 (AC Line Noise)5
雷サージ耐量 (Lightning Surge)5
静電気耐量 (ESD)5
6.その他の特性 (Other Characteristics)6
絶縁耐圧 (Withstand Voltage)6
絶縁抵抗 (Insulation Resistance)6
7.ダイナミック時の負荷特性 (Dynamic Load)6
図1(Fig.1):入力電流特性(負荷電流に対して) Input Current Characteristics (vs. Load Current)7
図2(Fig.2):力率特性(負荷電流に対して) Power Factor Characteristics (vs. Load Current)7
図3(Fig.3):効率特性(負荷電流に対して) Efficiency Characteristics (vs. Load Current)7
図4(Fig.4):突入電流特性(入力電圧に対して) Inrush Current Characteristics (vs. Input Voltage)8
図5(Fig.5):漏洩電流(入力電圧に対して) Leakage Current Characteristics (vs. Load Current)8
図6(Fig.6):出力電圧精度特性(負荷電流に対して) Output Voltage Accuracy Characteristics (vs. Load Current)8
図7(Fig.7):経時ドリフト特性 Warm-Up Drift Characteristics9
図8(Fig.8):リップル電圧特性(負荷電流に対して) Ripple Voltage Characteristics (vs. Load Current)9
図9(Fig.9):リップルノイズ電圧特性(負荷電流に対して) Ripple Noise Voltage Characteristics (vs. Load Current)9
図10(Fig.10):過電流特性(負荷電流に対して) Over Current Protection Characteristics (vs. Load Current)10
図11(Fig.11):過電圧特性(温度に対して) Over Voltage Protection Characteristics (vs. Temperature)10
図12(Fig.12):起動時間特性(入力電圧に対して) Start-Up Time Characteristics (vs. Input Voltage)10
図13(Fig.13):入力瞬断時間(負荷電流に対して) Holduptime Characteristics (vs. Load Current)11
図14(Fig.14):ダイナミック時の負荷波形 Dynamic Load Waveform11
図15(Fig.15):出力電圧立上り波形 Output Voltage Rising Waveform11
図16(Fig.16):出力電圧立下り波形 Output Voltage Falling Waveform12
図17(Fig.17):突入電流波形 Inrush Current Waveform12
図18(Fig.18):過電圧波形 Over Voltage Waveform12
図19(Fig.19):雑音端子電圧波形(Vin=100V) Conduction Noise Waveform(Vin=100V)13
図20(Fig.20):雑音端子電圧波形(Vin=240V) Conduction Noise Waveform(Vin=240V)13
試験回路図 : Test Circuit14

入力電圧 Input Voltage	MIN	85V
	NOM	100V
	MAX	240V

出力 Output Circuit		12V			
負荷電流 Load Current	MIN	0A			
	NOM	4.3A			
	MAX	4.3A			
	PEAK	—			

1.入力特性 Input Characteristics

Ta=+25°C

試験項目 Test Item	条件 Condition		試験結果 Test Results			仕様 SPEC	備考 Remarks
	入力 Vin	負荷 Load	Vin=100V	Vin=240V			
入力電流 Input Current	NOM	NOM	1.025A	0.550A		1.0A/0.5A typ	図1 Fig.1
入力電力 Input Power	NOM	NOM	60.10W	59.66W		---	
力率 Power Factor	NOM	NOM	0.584	0.451		0.50 typ.	図2 Fig.2
効率 Efficiency	NOM	NOM	86.07%	86.70%		84%/86% typ	図3 Fig.3
突入電流 Inrush Current	NOM	NOM	16.8A	35.4A ← Vin=200		15/30A typ.	図4 Fig.4
漏洩電流 Leakage Current	NOM	NOM	0.041mA	0.106mA ← Vin=230		0.15mA/0.30mA max	図5 Fig.5
起動停止電圧 Startup Voltage & Stop Voltage	---	MIN			ON29V・OFF10V	---	---
	---	NOM			ON60V・OFF57V	---	---
入力瞬断時間 Hold up time	100V	NOM			20ms(Ta=+25°C)	20ms typ.	図13 Fig.13

2.出力特性 Output Characteristics

*総合安定度:②+③+④ Output Regulation:②+③+④ Ta=+25°C

試験項目 Test Item		条件 Condition		試験結果 Test Results				備考 Remarks
		入力 Vin	負荷 Load					
				+12V				
1	出力偏差 Output Standard Voltage	NOM	NOM	12.033V				
2	入出力相互変動 Voltage Change Fluctuation	MIN	MIN	12.018V				図6 Fig.6
		MAX	MAX	12.052V				
3	温度ドリフト Temperature Drift	NOM	NOM	+5mV -15mV				図6 Fig.6
4	経時ドリフト Warm-Up Drift	NOM	NOM	+3mV -2mV				図7 Fig.7
総合安定度 Total Regulation				12.001V ~ 12.060V				
仕様 SPEC				11.640V ~ 12.360V				
5	リップル電圧 Ripple Voltage	NOM	NOM	31mV				図8 Fig.8
		室温 Room Temperature		Ta=+25°C				
仕様 SPEC				160mV(-10~0°C) 120mV(0~				
	リップルノイズ電圧 Ripple Noise Voltage	NOM	NOM	34mV				図9 Fig.9
		室温 Room Temperature		Ta=+25°C				
仕様 SPEC				180mV(-10~0°C) 150mV(0~				
6	出力電圧可変範囲 Output Voltage Variable Range	MIN	MIN	9.850V				
		MAX	MAX	14.237V				
仕様 SPEC				10.800V ~ 13.200V				
コメント Comment								
使用プローブ=リップル電圧1:1 リップルノイズ電圧1:1				Used Probe = Ripple Voltage 1:1 Ripple Noise Voltage 1:1				

3.保護特性 Protection Characteristics

試験項目 Test Item	条件 Condition		試験結果 Test Results			仕様 SPEC	備考 Remarks
	入力 Vin	負荷 Load					
過電流検出値 Over Current Protection			Ta=-10°C	Ta=+25°C	Ta=+60°C		
12V	NOM	---	5.58A	5.65A	5.70A	4.52A以上	図10 Fig.10
過電圧検出値 Over Voltage Protection			Ta=-10°C	Ta=+25°C	Ta=+60°C		
12V	NOM	MIN	15.48V	15.96V	16.44V	13.8V~16.8V	図11 Fig.11
リセット時間 Reset Time	MAX	MIN	81.4s, Ta =+25°C			---	---

4.環境試験 Environment Test

Ta=+25°C

試験項目 Test Item	条件 Condition		試験結果 Test Results			仕様 SPEC	備考 Remarks
	入力 Vin	負荷 Load					
振動試験(非動作時) Vibration (Non-Operating)	---	---	周波数10Hz~55Hz,周期3分,加速度2G X・Y・Z方向に各60分,にて試験後外観・特性に問題なし Frequency 10~55Hz, Sweep cycle 3min., Acceleration 19.6m/s ² , Direction X/Y/Z 60 minutes par each axis			正常に起動 Normal Operation	--
高温スタート Power on at high temp	NOM	NOM	POWOFFにて65°Cに1時間放置後POWERON Left the power supply at 65°Cfor one hour and turned on.			正常に起動 Normal Operation	--
低温スタート Power on at low temp	NOM	NOM	POWOFFにて-15°Cに1時間放置後POWERON Left the power supply at -15°Cfor one hour and turned on.			正常に起動 Normal Operation	--
耐衝撃 Shock	---	---	床面から50mmの高さより各辺3回自然落下後 外観・特性に問題なし 98m/s ² . Conduct this test on an oak board with a flat surface and a thickness of 10mm or more. Lift one side of surface of the unit 50mm and drop it on the board. Drop 3 times for each side.			98m/s ² 正常に起動 Normal Operation	--

5.耐ノイズ特性 Noise Tolerance Characteristics

Ta=+25°C

試験項目 Test Item	条件 Condition		試験結果 Test Results			仕様 SPEC	備考 Remarks
	入力 Vin	負荷 Load					
注入ノイズ耐量 ACLInoise (50ns~1000ns)	MIN ~ MAX	MIN ~ NOM	L-L L-FG N-FG	±2.4 ±2.4 ±2.4	kV No Err, No Damage kV No Err, No Damage kV No Err, No Damage	L-L, L-FG : ±2kV 50ns ~ 1000ns 0° ~ 360°	---
雷サージ耐量 LightningSurge (1.2 × 50 μs)	NOM	NOM	L-L L-FG N-FG	±2.4 ±2.4 ±2.4	kV No Err, No Damage kV No Err, No Damage kV No Err, No Damage	L-L, L-FG : ±2.0kV (3 times)	---
静電気耐量ESD	MIN ~ MAX	MIN ~ MAX	Contact Air C: 150pF, R: 330Ω	±8.4 ±11.2	kV No Err, No Damage kV No Err, No Damage	Contact ; ±6kV Air ; ±8kV	---

6.その他の特性 Other Characteristics

Ta=+25°C

試験項目 Test Item	条件 Condition		試験結果 Test Results			仕様 SPEC	備考 Remarks
	入力 Vin	負荷 Load					
絶縁耐圧 Withstand Voltage	---	---	P-S 3.0/3.6kV (漏電流) Leakage Current: 1.67/1.85mA	P-FG 2.0/2.4kV (漏電流) Leakage Current: 1.41/1.59mA	S-FG 0.5/0.6kV (漏電流) Leakage Current: 0.78/0.87mA	P-S:3.0kV1m, 3.6kV1s P-E:2.0kV1m, 2.4kV1s S-E:0.5kV1m, 0.6kV1s (漏電流15mA以下) Leakage Current 15mA or less	--
絶縁抵抗 Insulation Resistance	---	---	P-S 1000MΩ以上 (or more)	P-FG 1000MΩ以上 (or more)	S-FG 1000MΩ以上 (or more)	P-S100MΩ以上(DC500V効 ⁺) P-S100MΩ or more (DC500VMegger)	---

7.ダイナミック時の負荷特性 Dynamic Load Characteristics 参考データ Reference data

試験条件 Test Condition		試験結果 Test Results				備考 Remarks
		12V				
出力電圧 Output Voltage	条件	Ta=-10°C	11.300V 12.200V			図14
		Ta=60°C	11.100V 12.300V			
	Condition	入力電圧 Vin	MIN			Fig.14
		出力電流	0A (10ms) ~ 4.3A (10ms)			
	仕様 SPEC		---			

図1 入力電流特性(負荷電流に対して)
Fig.1 Input Current Characteristics (vs Load Current)

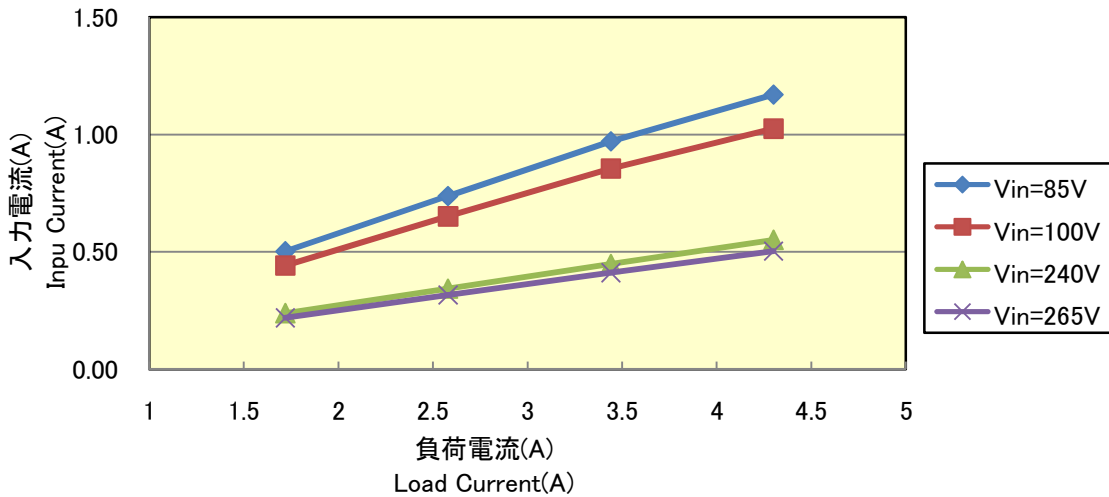

型名:Model	CWB050-12
入力:Input	AC85V~265V
出力:Output	12V、40%~100%
温度:Temperature	Ta=+25°C
備考:Remarks	

図2 力率特性(負荷電流に対して)
Fig.2 Power Factor Characteristics (vs Load Current)

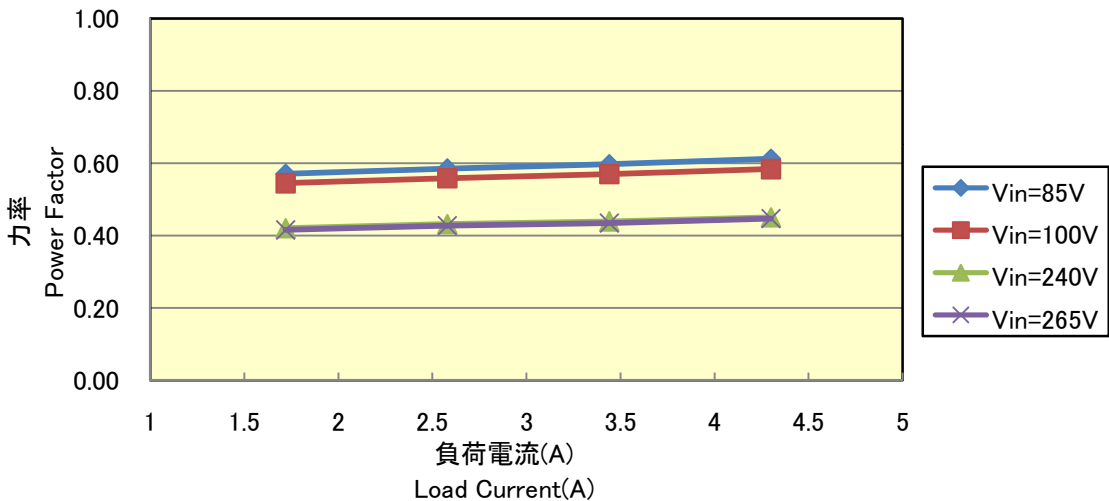

型名:Model	CWB050-12
入力:Input	AC85V~265V
出力:Output	12V、40%~100%
温度:Temperature	Ta=+25°C
備考:Remarks	

図3 効率特性(負荷電流に対して)
Fig.3 Efficiency Characteristics (vs Load Current)

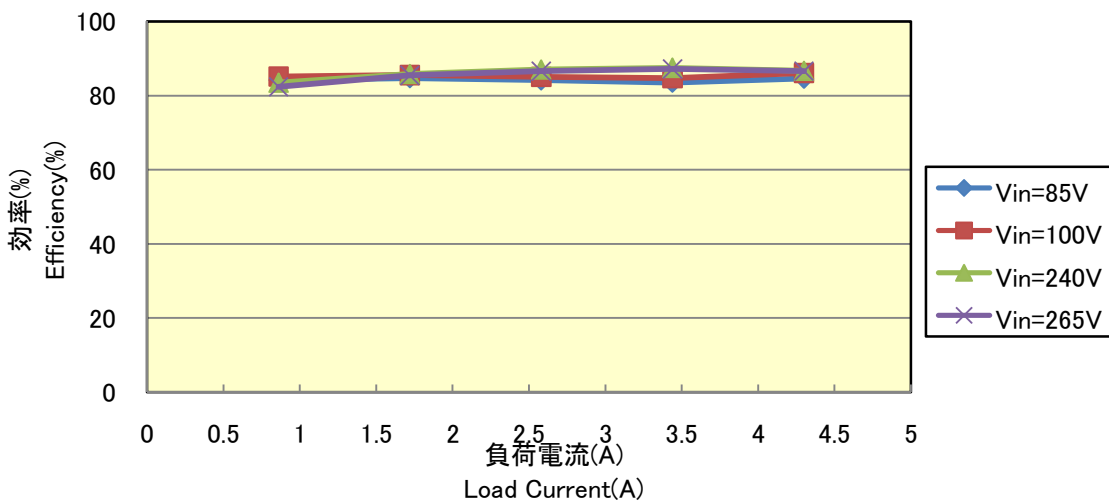

型名:Model	CWB050-12
入力:Input	AC85V~265V
出力:Output	12V、20%~100%
温度:Temperature	Ta=+25°C
備考:Remarks	

図4 突入電流特性(入力電圧に対して)
Fig.4 Inrush Current Characteristics (vs Input Voltage)

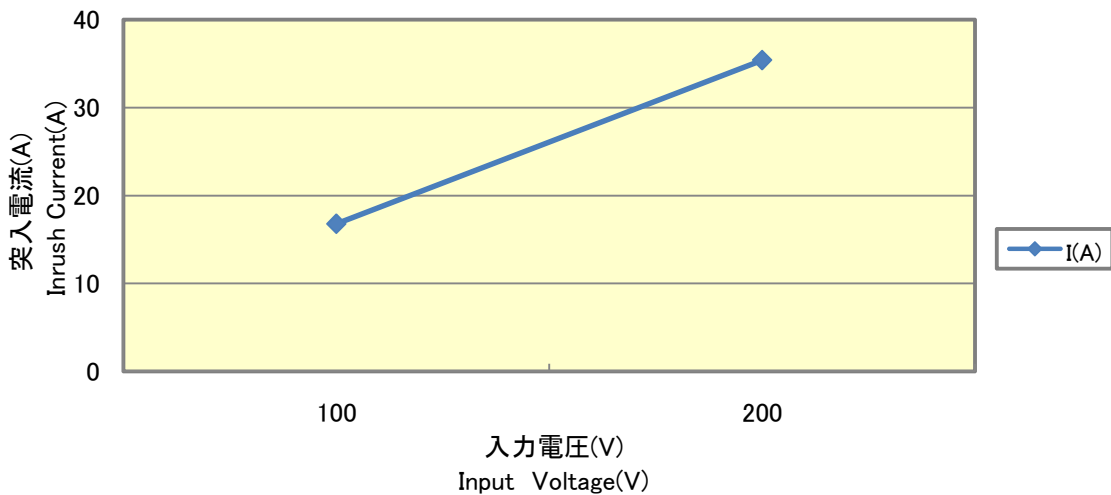

型名:Model	CWB050-12
入力:Input	AC100~200V
出力:Output	12V 4.3A
温度:Temperature	+25°C
備考:Remarks	コールドスタート時 Cold Start

図5 漏洩電流特性(入力電圧に対して)
Fig.5 Leakage Current Characteristics (vs Load Current)

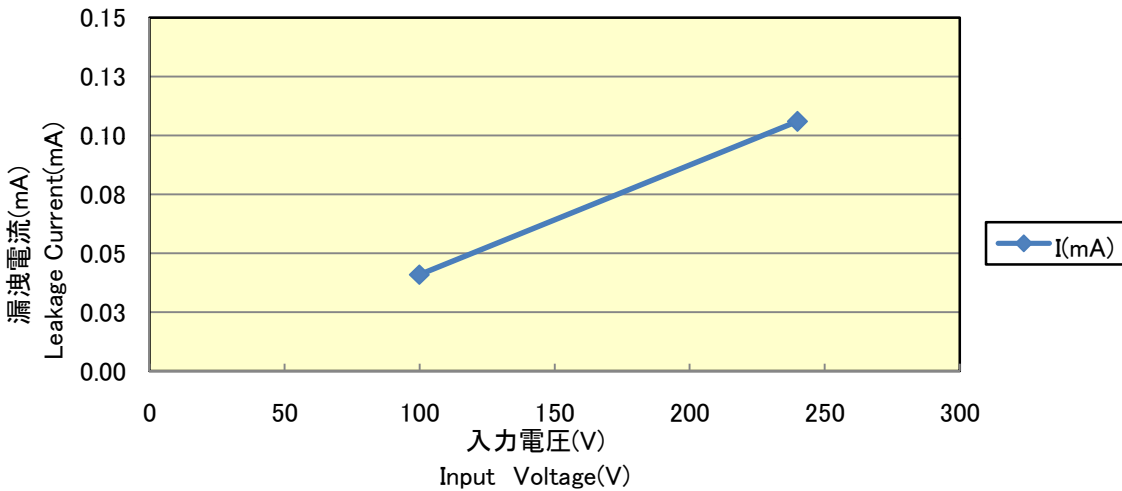

型名:Model	CWB050-12
入力:Input	AC100V~240V
出力:Output	Io=4.3A
温度:Temperature	Ta=+25°C
備考:Remarks	

図6 出力電圧精度特性(負荷電流に対して)
Fig.6 Output Voltage Accuracy Characteristics (vs Load Current)

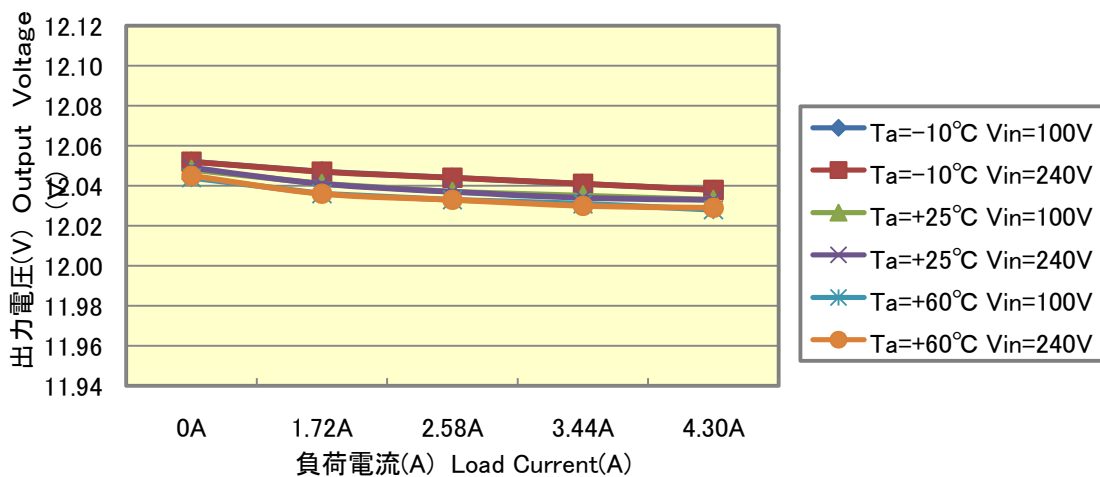

型名:Model	CWB050-12
入力:Input	AC100~240V
出力:Output	12V、0%~100%
温度:Temperature	Ta=-10°C~+60°C
備考:Remarks	

図7 経時ドリフト特性
Fig.7 Warm-Up Drift Characteristics

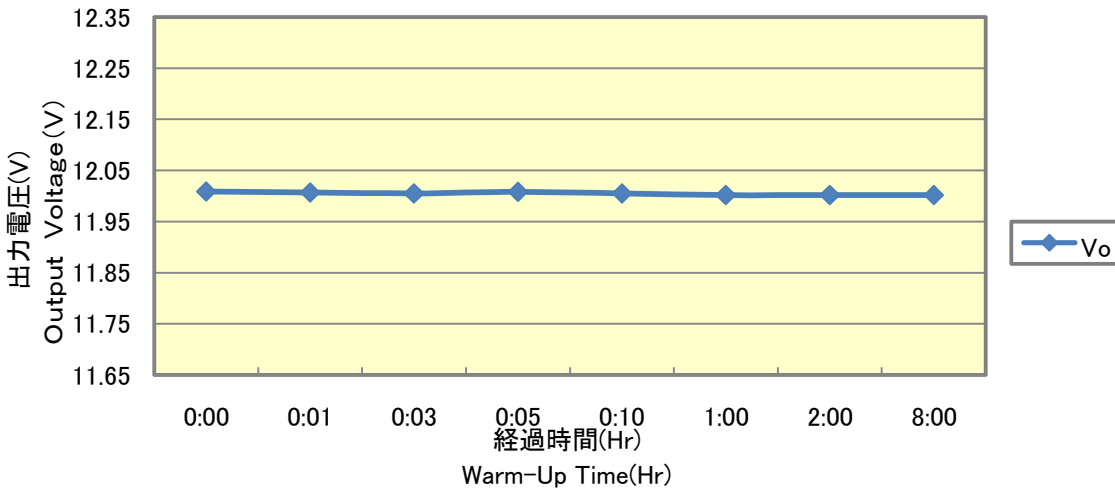

型名:Model	CWB050-12
入力:Input	AC100V
出力:Output	12V 4.3A
温度:Temperature	Ta=+25°C
備考:Remarks	

図8 リップル電圧特性(負荷電流に対して)
Fig.8 Ripple Voltage Characteristics (vs Load Current)

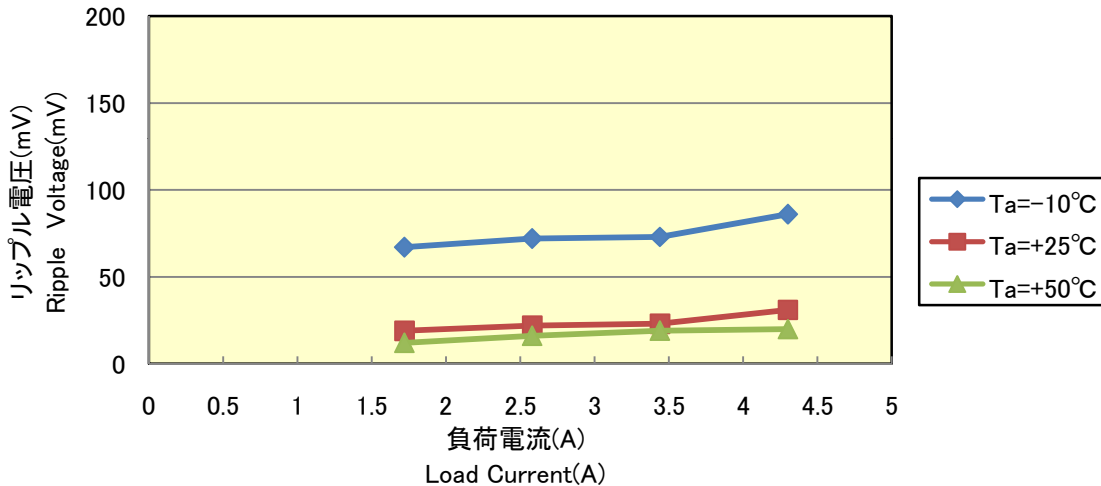

型名:Model	CWB050-12
入力:Input	AC100V
出力:Output	12V, 40%~100%
温度:Temperature	Ta=-10°C~+60°C
備考:Remarks	

図9 リップルノイズ電圧特性(負荷電流に対して)
Fig.9 Ripple Noise Voltage Characteristics (vs Load Current)

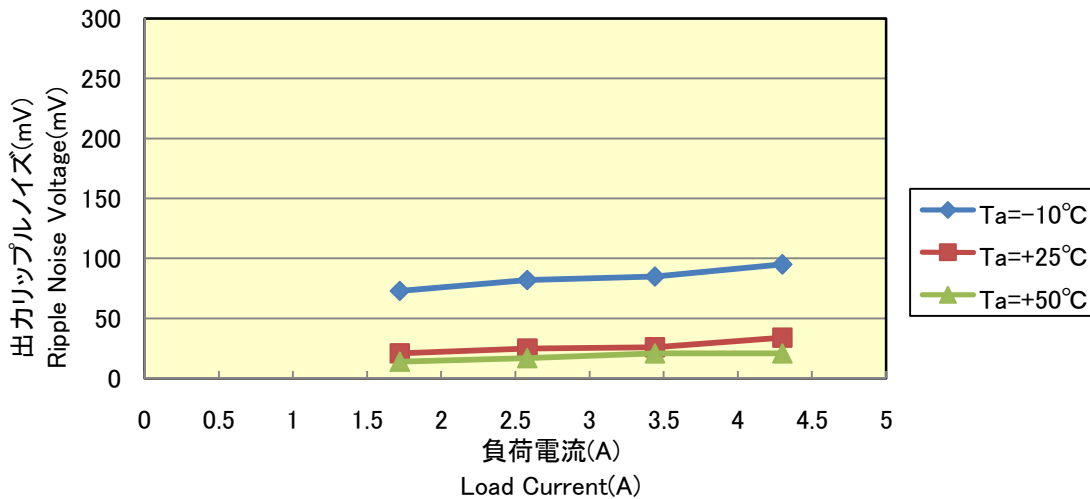

型名:Model	CWB050-12
入力:Input	AC100V
出力:Output	12V, 40%~100%
温度:Temperature	Ta=-10°C~Ta=50°C
備考:Remarks	

図10 過電流特性(負荷電流に対して)
Fig.10 Over Current Protection Characteristics (vs Load Current)

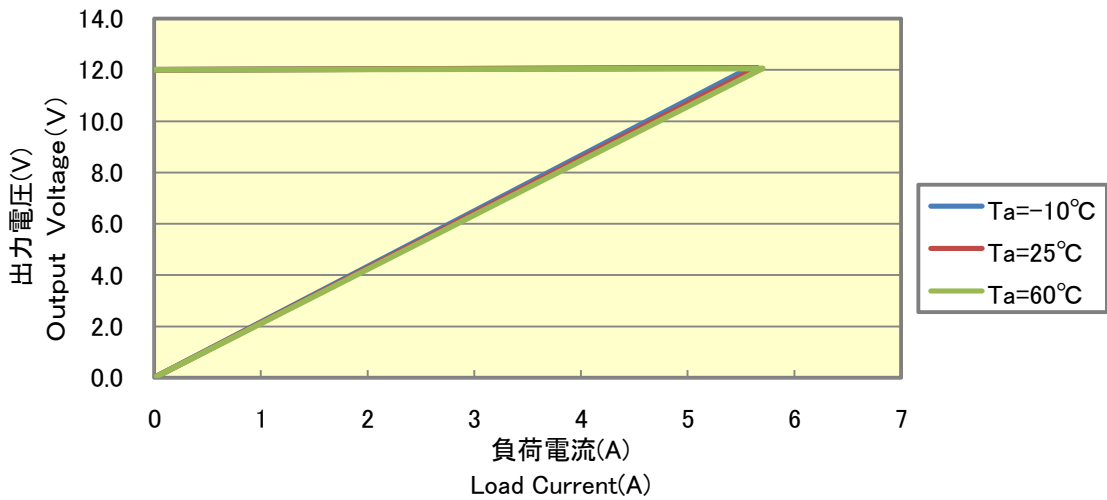

型名:Model	CWB050-12
入力:Input	AC100V
出力:Output	12V
温度:Temperature	Ta=-10°C~+60°C
備考:Remarks	

図11 過電圧特性(温度に対して)
Fig.11 Over Voltage Protection Characteristics (vs Temperature)

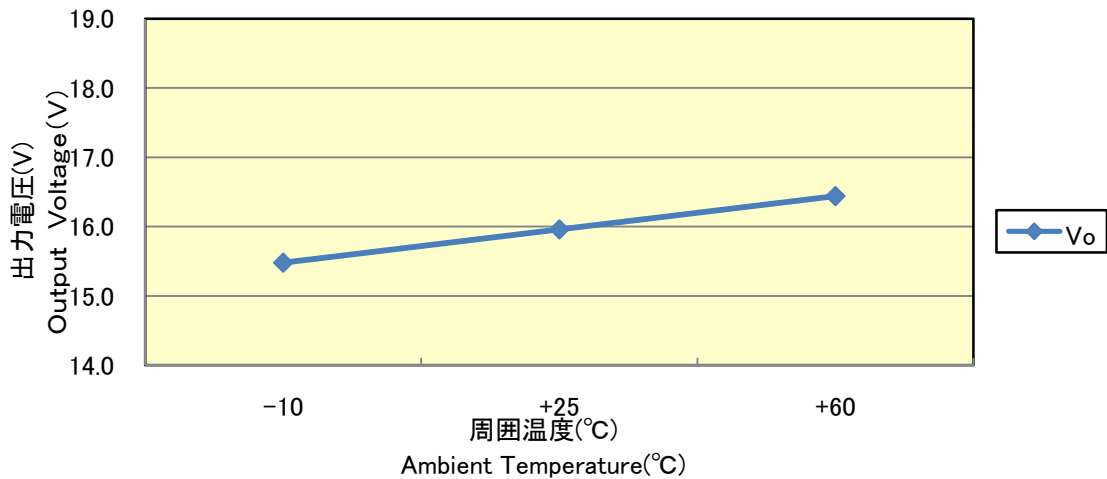

型名:Model	CWB050-12
入力:Input	AC100V
出力:Output	Io=0A
温度:Temperature	Ta=-10°C~+60°C
備考:Remarks	

図12 起動時間特性(入力電圧に対して)
Fig.12 Start-Up Time Characteristics (vs Input Voltage)

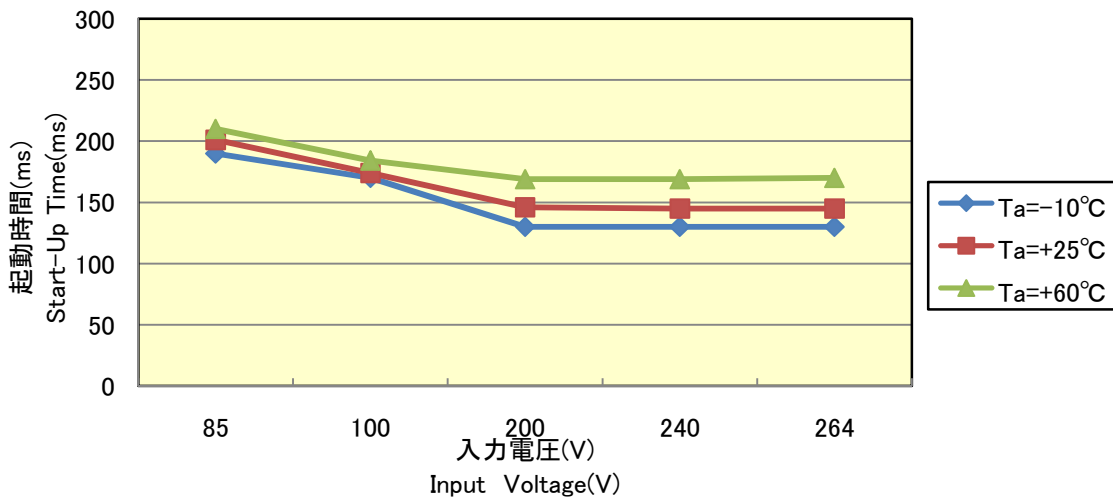

型名:Model	CWB050-12
入力:Input	AC85V~265V
出力:Output	Io=4.3A
温度:Temperature	Ta=-10°C~+60°C
備考:Remarks	

図13 入力瞬断時間(負荷電流に対して)
Fig.13 Hold up time Characteristics (vs Load Current)

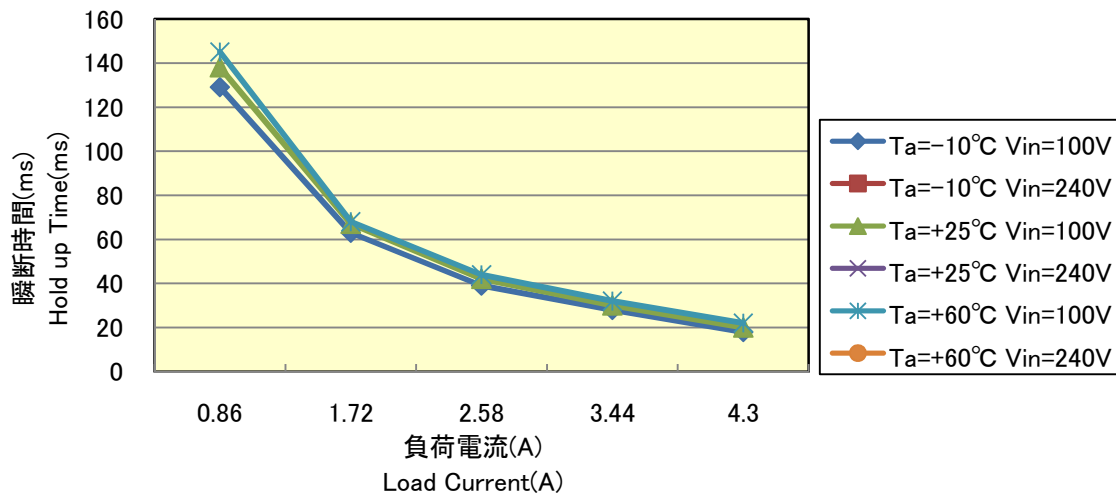

型名:Model	CWB050-12
入力:Input	AC100V~240V
出力:Output	12V, 20%~100%
温度:Temperature	Ta=-10°C~+60°C
備考:Remarks	

図14 ダイナミック時の負荷波形
Fig.14 Dynamic Load Waveform

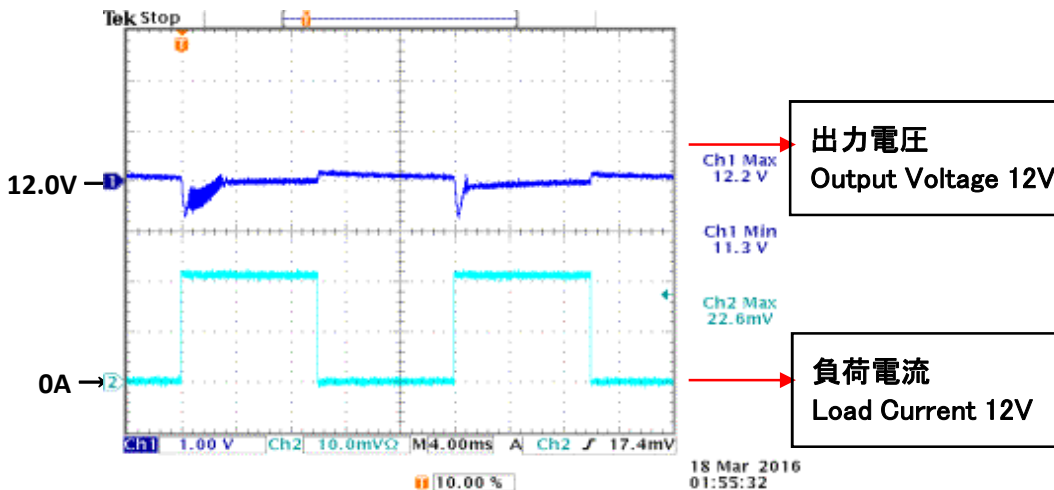

型名:Model	CWB050-12
入力:Input	Vin=85V
出力:Output	Io=0A⇔4.3A
温度:Temperature	Ta=+25°C
備考:Remarks	
出力電圧	OutputVoltageVertical: 1V/div
負荷電流	LoadCurrentVertical: 2A/div
時間	TimeHorizontal: 4ms/div

図15 出力電圧立上り波形
Fig.15 Output Voltage Rising Waveform

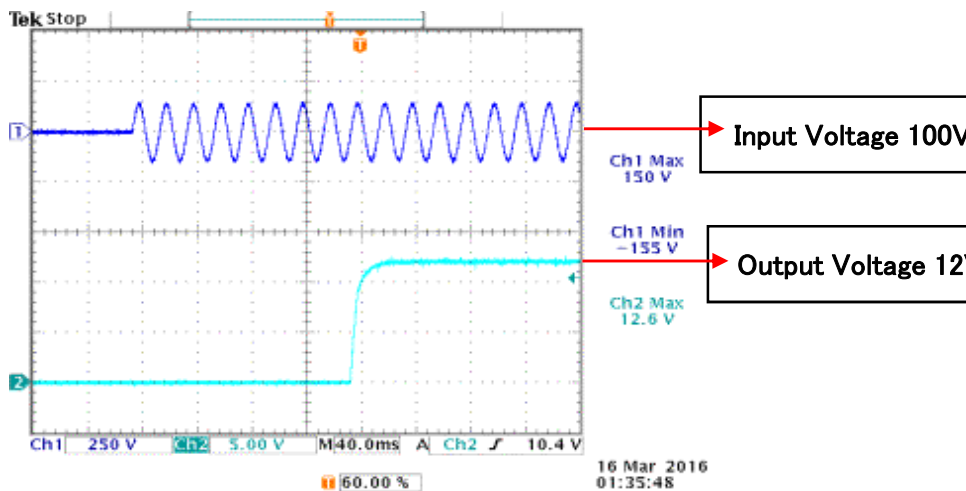

型名:Model	CWB050-12
入力:Input	Vin=100V
出力:Output	Io=4.3A
温度:Temperature	Ta=+25°C
備考:Remarks	
入力電圧	InputVoltageVertical: 250V/div
出力電圧	OutputVoltageVertical: 5V/div
時間	TimeHorizontal: 40ms/div

図16 出力電圧立下り波形
Fig.16 Output Voltage Falling Waveform

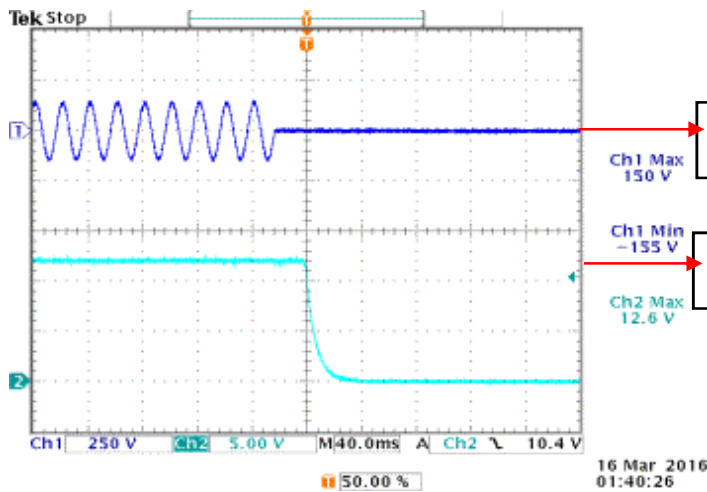

型名:Model	CWB050-12
入力:Input	Vin=100V
出力:Output	Io=4.3A
温度:Temperature	Ta=+25°C
備考:Remarks	入力電圧 InputVoltageVertical: 250V/div 出力電圧 OutputVoltageVertical: 5V/div 時間 TimeHorizontal: 40ms/div

図17 突入電流波形
Fig.17 Inrush Current Waveform

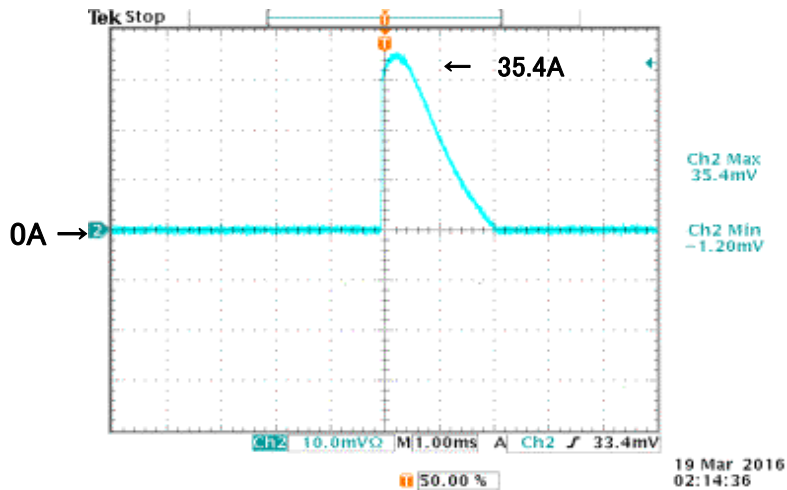

型名:Model	CWB050-12
入力:Input	Vin=200V
出力:Output	Io=4.3A
温度:Temperature	Ta=+25°C
備考:Remarks	出力電圧 InrushCurrentVertical: 10A/div 時間 TimeHorizontal: 1ms/div

図18 過電圧波形
Fig.18 Over Voltage Waveform

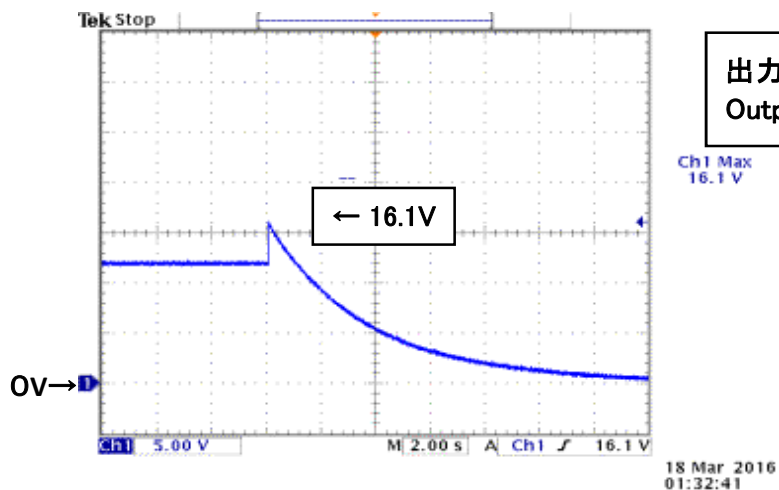

型名:Model	CWB050-12
入力:Input	Vin=265V
出力:Output	Io=0A
温度:Temperature	Ta=+25°C
備考:Remarks	出力電圧 OutputVoltageVertical: 5V/div 時間 TimeHorizontal: 2s/div

図19 雑音端子電圧波形
Fig.19 Conduction Noise Waveform

Model Name : CWB050-12
 Model No. :
 Serial No. :
 Power Supply :
 Memo :
 LISN Va Vb Det.Mode : PEAK
 Test Mode :
 Temp/Humi :
 Operator :
 Limit : CISPR classB QP

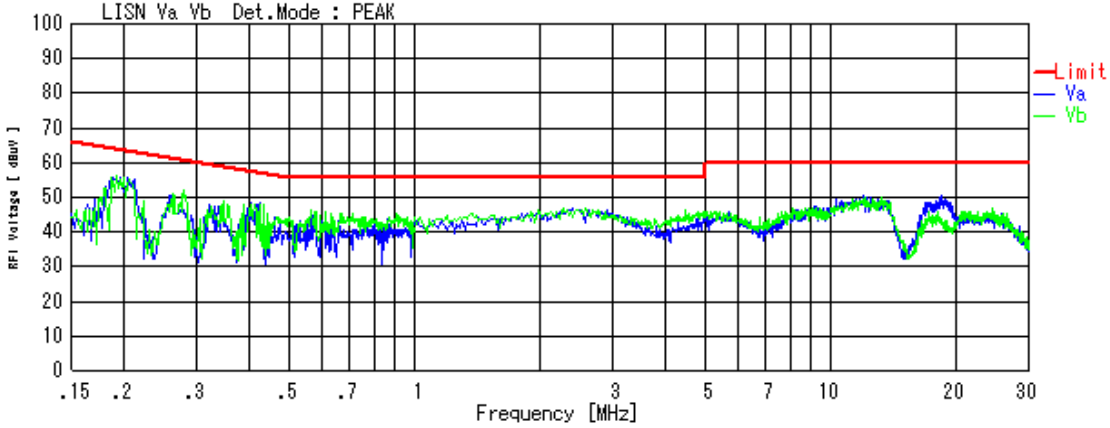

型名:Model	CWB050-12
入力:Input	Vin=100V
出力:Output	Io=4.3A
温度:Temperature	Ta=+25°C
備考:Remarks	

図20 雑音端子電圧
Fig.20 Conduction Noise Waveform

Model Name : CWB050-12
 Model No. :
 Serial No. :
 Power Supply :
 Memo :
 LISN Va Vb Det.Mode : PEAK
 Test Mode :
 Temp/Humi :
 Operator :
 Limit : CISPR classB QP

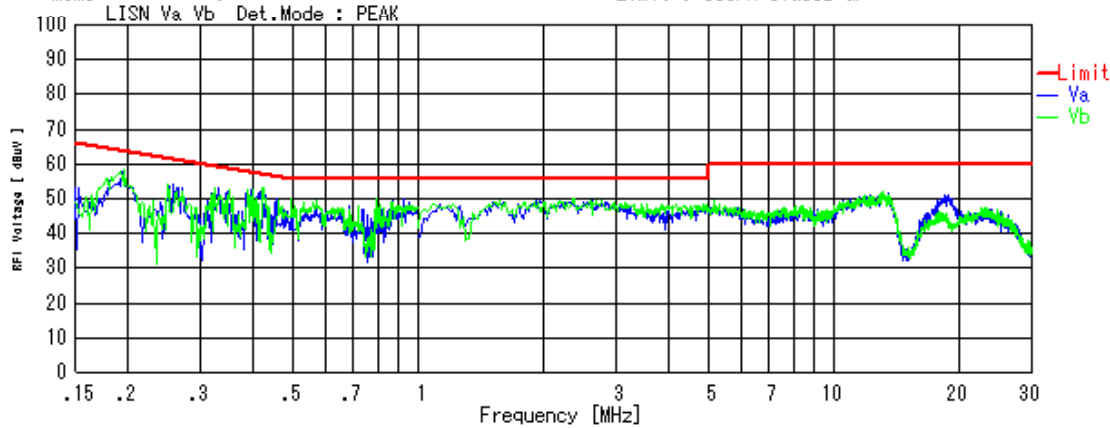

型名:Model	CWB050-12
入力:Input	Vin=240V
出力:Output	Io=4.3A
温度:Temperature	Ta=+25°C
備考:Remarks	

試験回路図 Test Circuit

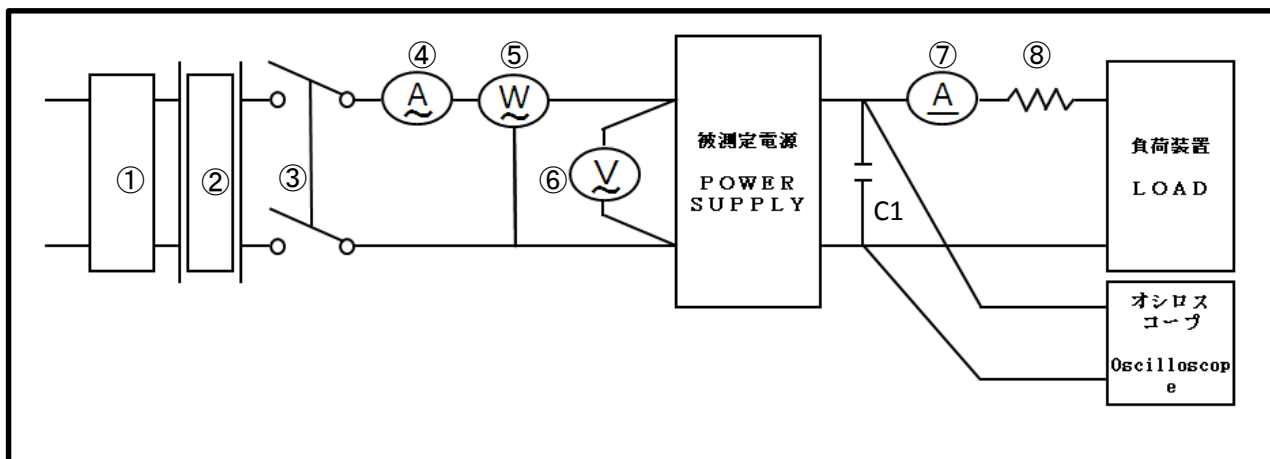

使用計測機器

- ①スライダック
- ②絶縁トランス
- ③ブレーカー
- ④電流計
- ⑤電力計
- ⑥電圧計
- ⑦電流計
- ⑧シャント抵抗

Measuring instruments

- Variable autotransformer
- Isolation transformer
- A circuit breaker
- Ammeter
- Wattmeter
- Voltmeter
- Ammeter
- Shunt resistor

2次側出力電圧はDMMで測定

Output voltage is measured with DMM

- 負荷コンデンサ Load capacitor
- 12V Circuit C1 : Electrolytic Capacitor 100 μ F
- Film Capacitor 0.1 μ F