



No. CHD40004-014A00

参考資料
Reference data

TECHNICAL DATA

MODEL: C130X24

SANKEN ELECTRIC CO.,LTD.

CHD40004-014A00
March 08, 2013

Model: C130X24

入力電圧 Input Voltage	MIN	----
	NOM	----
	MAX	----

出力 Output Circuit		24V			
負荷電流 Load Current	MIN	0A			
	NOM	5.5A			
	MAX	5.5A			

1.入力特性 Input Characteristics

Ta=25°C

試験項目 Test Item	条件 Condition		試験結果 Test Results			仕様 SPEC	備考 Remarks
	入力 Vin	負荷 Load	Vin=21V				
効率 Efficiency	NOM	NOM	96.8%			95.0%	図1 Fig.1

Model: C130X24

2.出力特性 Output Characteristics *総合安定度:②+③+④ Output Regulation:②+③+④ Ta=25°C

試験項目 Test Item		条件 Condition		試験結果 Test Results				備考 Remarks
		入力 Vin	負荷 Load					
				24.4				
1	出力電圧設定値 Output Setting Voltage	NOM	NOM	24.41V				---
2	入出力相互変動 Voltage Change Fluctuation	MIN	MIN	24.41V				図2 Fig.2
		MAX	MAX	24.43V				
3	温度ドリフト Temperature Drift	NOM	NOM	-89mV +40mV				図2 Fig.2
4	経時ドリフト Warm-Up Drift	NOM	NOM	+4mV				図3 Fig.3
総合安定度 Total Regulation				24.32 ~ 24.54				
静的負荷変動幅 Static Load Regulation (※1)				±1.20V				---
5	リップル電圧 Ripple Voltage (※2)	NOM	NOM	15mV				図4 Fig.4
		室温 Room Temperature		Ta=25°C				
仕様 SPEC				250mV				
	リップルノイズ電圧 Ripple Noise Voltage (※3)	NOM	NOM	16mV				図5 Fig.5
		室温 Room Temperature		Ta=25°C				
仕様 SPEC				250mV				
6	出力電圧可変範囲 Output Voltage Variable Range	仕様 SPEC		24.0V ~ 26.4V				
コメント Comment								
※1	出力電圧可変範囲内で設定された出力電圧値に対する静的な変動幅です。 This shows the static load regulation against output voltage value set within output variable voltage range.							
※2	使用プローブ=リップル電圧1:1				Used Probe = Ripple Voltage 1:1			
※3	リップルノイズ電圧1:1				Ripple Noise Voltage 1:1			

Model: C130X24

3.保護特性 Protection Characteristics

試験項目 Test Item	条件 Condition		試験結果 Test Results			仕様 SPEC	備考 Remarks
	入力 Vin	負荷 Load					
過電流検出値 Over Current Protection			Ta=-20°C	Ta=25°C	Ta=50°C		
+24V	MIN	MAX	8.0A	8.0A	8.0A	5.8A以上(or more)	図6 Fig.6
	MIN	MAX					
過電圧検出値 Over Voltage Protection			Ta=-20°C	Ta=25°C	Ta=70°C		
+24V	NOM	MIN	30.1V	31.2V	32.0V	27.6V以上(or more)	図7
	NOM	MIN					#N/A

4.環境試験 Environment Test

Ta=25°C

試験項目 Test Item	条件 Condition		試験結果 Test Results			仕様 SPEC	備考 Remarks
	入力 Vin	負荷 Load					
振動試験(非動作時) Vibration (Non-Operating)	---	---	周波数10Hz~55Hz,周期3分,加速度2G X・Y・Z方向に各30分,にて試験後外観・特性に問題なし Frequency 10~55Hz, Sweep cycle 3min., Acceleration 19.6m/s ² , Direction X/Y/Z 60 minutes per each axis			正常に起動 Normal Operation	--
高温スタート Power on at high temp	NOM	MAX	POW OFFにて65°Cに1時間放置後POWER ON Left the power supply at 65°Cfor one hour and turned on.			正常に起動 Normal Operation	--
低温スタート Power on at low temp	NOM	MAX	POW OFFにて-15°Cに1時間放置後POWER ON Left the power supply at -15°Cfor one hour and turned on.			正常に起動 Normal Operation	--
耐衝撃 Shock	---	---	床面から50mmの高さより各辺3回自然落下後 外観・特性に問題なし 98m/s ² . Conduct this test on an oak board with a flat surface and a thickness of 10mm or more. Lift one side of surface of the unit 50mm and drop it on the board. Drop 3 times for each side.			98m/s ² 正常に起動 Normal Operation	--

5.その他の特性 Other Characteristics

Ta=25°C

試験項目 Test Item	条件 Condition		試験結果 Test Results			仕様 SPEC	備考 Remarks
	入力 Vin	負荷 Load					
絶縁耐圧 Withstand Voltage	---	---	P-S ---kV (漏電流) Leakage Current ---mA	P-E ---kV (漏電流) Leakage Current ---mA	S-E 0.6kV (漏電流) Leakage Current 0mA	S-E:500V 1m, 600V 1s (漏電流15mA以下) Leakage Current 15mA or less	--
絶縁抵抗 Insulation Resistance	---	---	P-S--- (or more)	P-E--- (or more)	S-E1000MΩ 以上 (or more)	S-E 100MΩ 以上(DC500Vメーガ-) P-S50MΩ or more (DC500VMegeger)	--

図1 効率特性(負荷電流に対して)
Fig.1 Efficiency Characteristics (vs. Load Current)

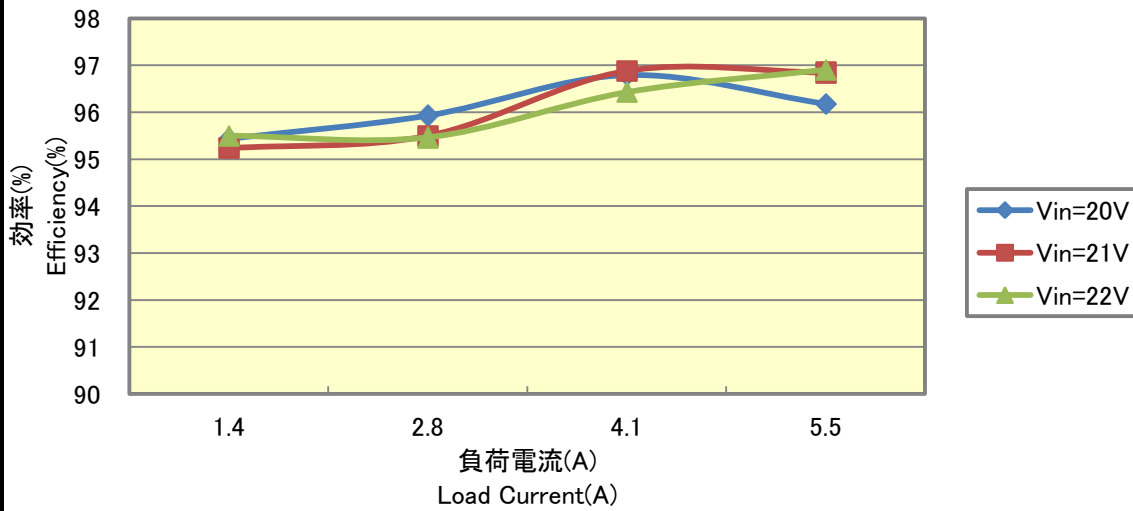

型名:Model	C130X24
入力:Input	DC20~22V
出力:Output	24.4V, 25%~100%
温度:Temperature	25°C
備考:Remarks	

図2 出力電圧精度特性(負荷電流に対して)
Fig.2 Output Voltage Accuracy Characteristics (vs. Load Current)

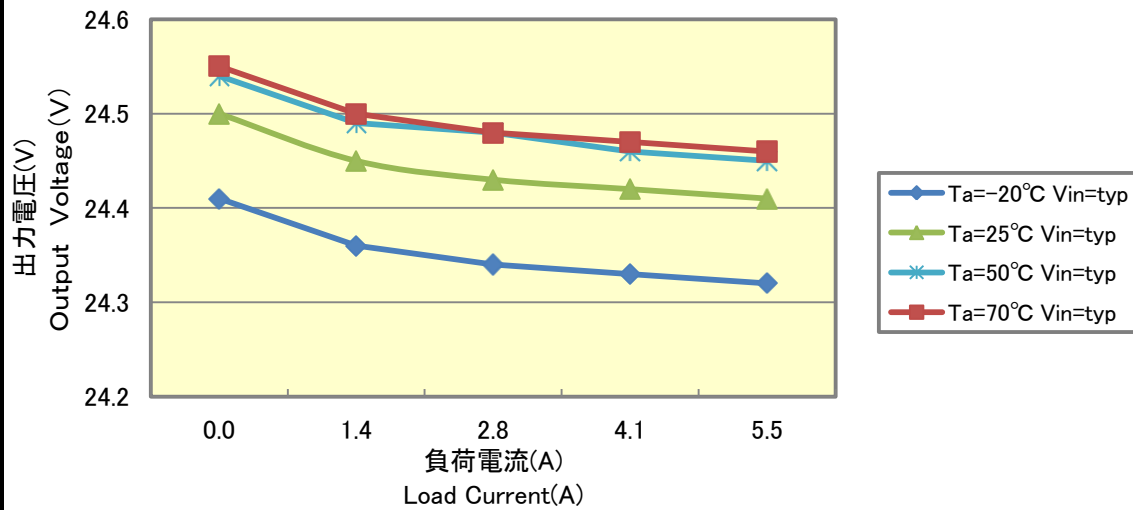

型名:Model	C130X24
入力:Input	DC20~22V
出力:Output	24.4V, 25%~100%
温度:Temperature	Ta=-20°C~Ta=70°C
備考:Remarks	

図3 経時ドリフト特性
Fig.3 Warm-Up Drift Characteristics

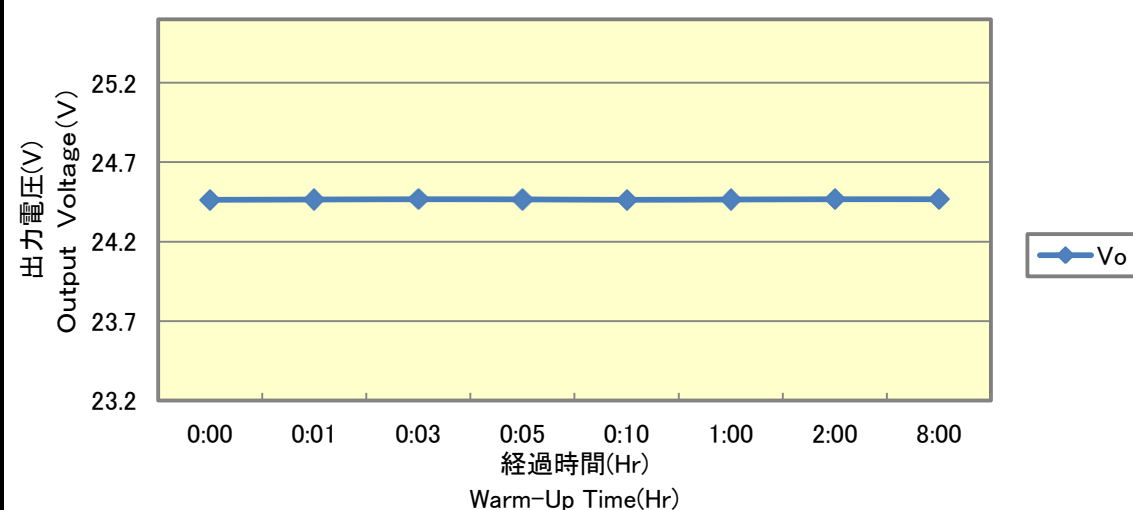

型名:Model	C130X24
入力:Input	DC21V
出力:Output	24.4V, 5.5A
温度:Temperature	Ta=25°C
備考:Remarks	

図4 リプル電圧特性(負荷電流に対して)
Fig.4 Ripple Voltage Characteristics (vs. Load Current)

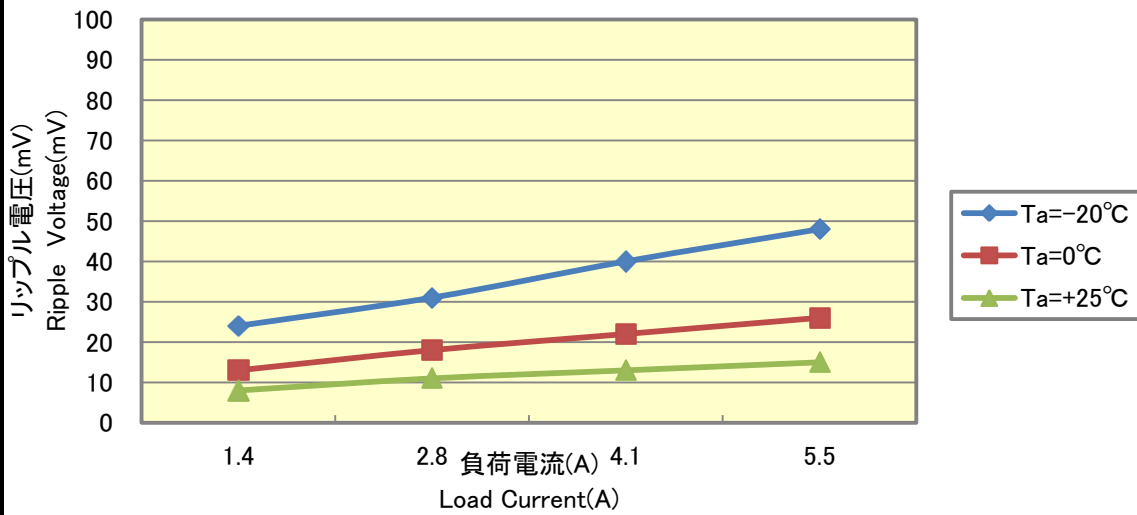

型名:Model	C130X24
入力:Input	DC21V
出力:Output	24.4V、25%~100%
温度:Temperature	Ta=-20~Ta=25
備考:Remarks	

図5 リプルノイズ電圧特性(負荷電流に対して)
Fig.5 Ripple Noise Voltage Characteristics (vs. Load Current)

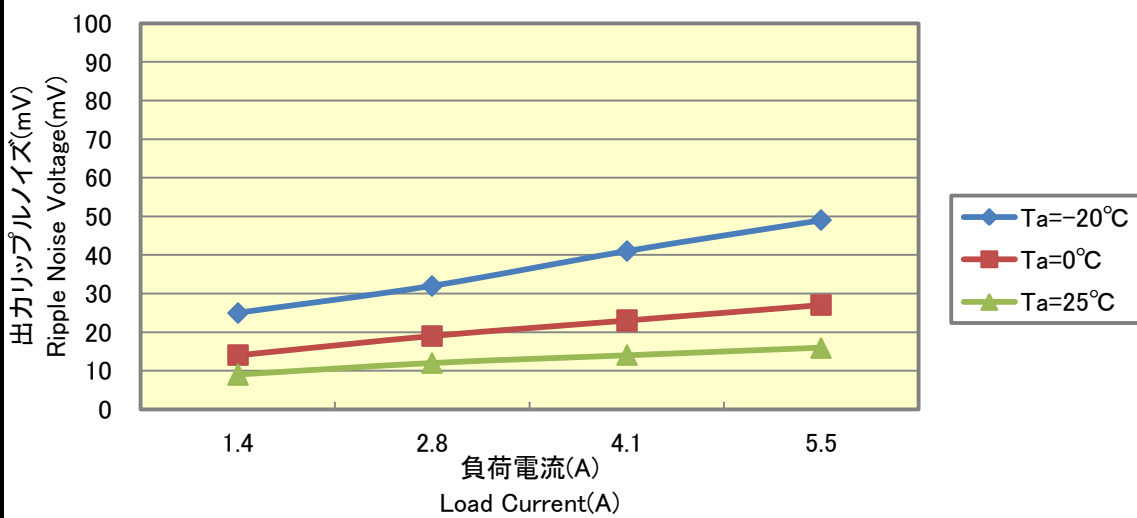

型名:Model	C130X24
入力:Input	DC21V
出力:Output	24.4V、25%~100%
温度:Temperature	Ta=-20~Ta=25
備考:Remarks	

図6 過電流特性(負荷電流に対して)
Fig.6 Over Current Protection Characteristics (vs. Load Current)

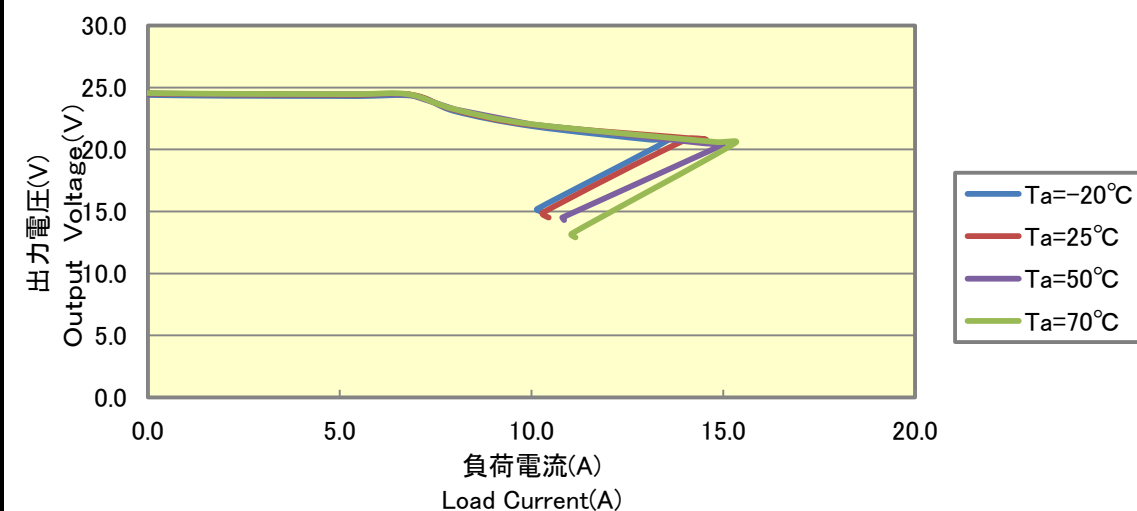

型名:Model	C130X24
入力:Input	DC21V
出力:Output	24.4V
温度:Temperature	Ta=-20°C~Ta=70°C
備考:Remarks	

図7 過電圧特性(温度に対して)
Fig.7 Over Voltage Protection Characteristics (vs. Temperature)

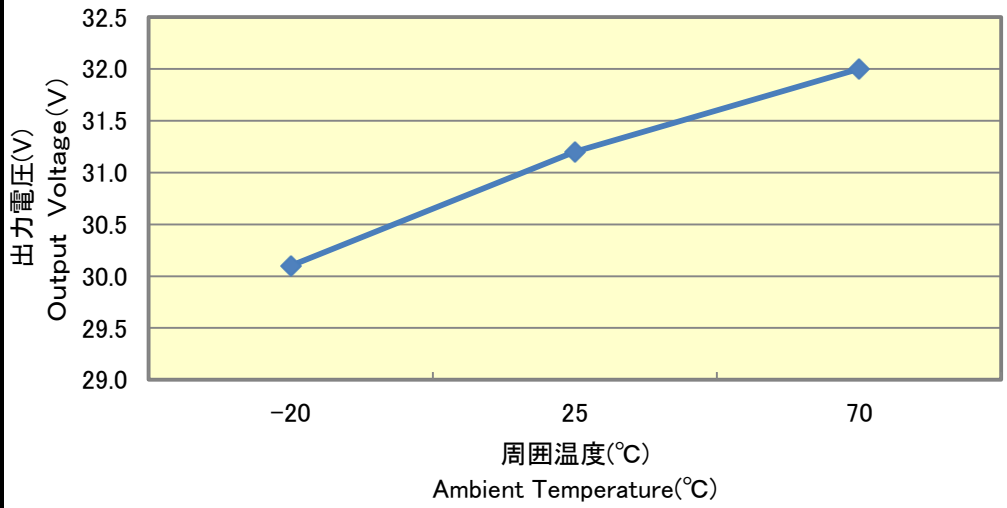

型名:Model	C130X24
入力:Input	DC21V
出力:Output	24.4V0A
温度:Temperature	Ta=-20~70°C
備考:Remarks	

Vo

試験回路図 Test Circuit

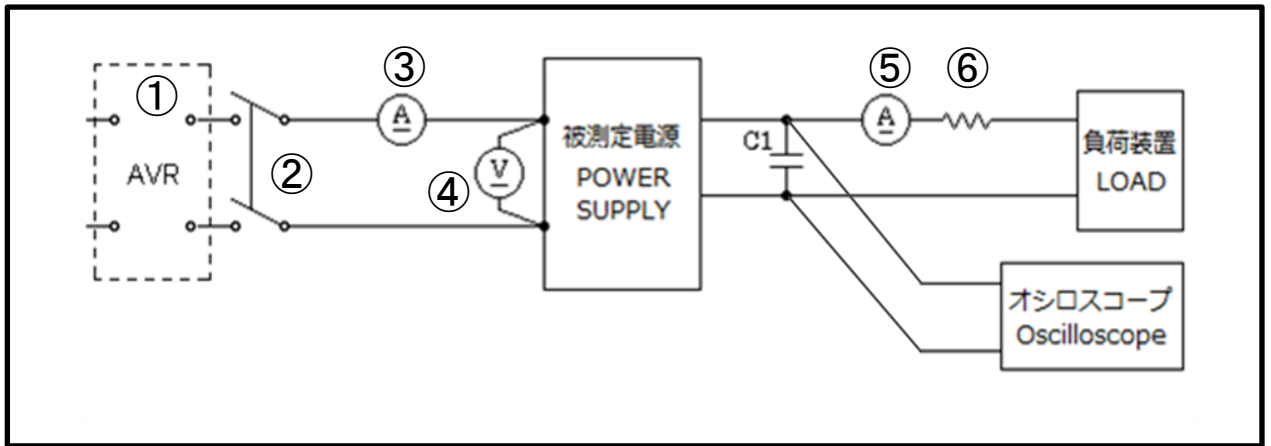

使用計測機器

- ①外部電源
- ②ブレーカー
- ③電流計
- ④電圧計
- ⑤電流計
- ⑥シャント抵抗

- Measuring instruments
 Automatic Voltage Regulator
 A circuit breaker
 Ammeter
 Voltmeter
 Ammeter
 Shunt resistor

2次側出力電圧はDMMで測定
 Output voltage is measured with DMM

- 負荷コンデンサ Load capacitor
 Circuit C1: Electrolytic Capacitor 47 μ F
 Film Capacitor 0.1 μ F